

# Wall Merchandising Systems

**Kember Store Metals Limited**

500 Applewood Crescent, Vaughan, Ontario, Canada L4K 4B4  
Telephone: 905-660-5268 1-800-587-5770 Fax: 905-660-4948

CATALOGUE #	PAGE	CATALOGUE #	PAGE	CATALOGUE #	PAGE
<b>3000 SERIES</b>				<b>9000 SERIES</b>	
Miscellaneous & Hangrod					
3001	3	5016	8	9001	4
3002	3	5020	6	9002	4
3003	3	5021	6	9003	4
3004	3	5022	6	9004	5
3005	3	5023	7	9005	5
3005	3	5024	7	9015	8
3006	9	5025	8	9016	8
3008	9	5026	8	9020	6
3009	9	5027	7	9021	6
3010	9	5028	8	9022	6
3011	9	5030	10	9023	7
3030	9	5031	10	9024	7
3031	9	5032	10	9025	8
3032	9	5037	6	9026	8
3040	15			9027	7
3041	15			9028	8
3042	15	<b>6000 SERIES</b>		9030	10
3043	15	Hangrail		9031	10
3044	15			9032	10
3045	15	6006	10	9037	6
		6007	10		
		6008	10		
		6009	10		
		6010	10		
		6015	11		
		6015	11		
		6016	11		
		6025	11		
		6026	11		
		6028	12		
		6033	12		
		6038	12		
		6039	12		
<b>5000 SERIES</b>					
5001	4				
5003	4				
5004	5				
5010	5				
5011	5				
5012	5				
5015	8				

At Kember Store Metals Limited we specialize in manufacturing high quality hardware and custom metal work.

We manufacture two slotted standards, a light duty and a heavy duty, both have a place in merchandising.

KSM9000 system is ideal in many locations where strength is not paramount, such as displays for shoes, greeting cards and light clothing. The basic wall standard is 3/4" wide. We also make narrow single slotted as well as double slotted and recessed standards.

KSM5000 heavy duty 5/8" slot system is designed to meet all your merchandising needs. The heart of the system is the wall standards; manufactured from 14 gauge cold rolled steel with 5/8" x 1/8" slots on 1" centres. It is strong enough for areas selling hardware and heavy coats, but it's slim profile makes it suitable for merchandise requiring a lighter look. Because of the systems versatility, it is practical and economical to use throughout the store, both in sales and storage areas.

For speciality areas where strength is not of primary importance, we have a narrow standard only 3/8" wide. Another variation is our recessed standard which when installed has an extremely neat appearance. Double slotted standards are available for those who prefer them.

To compliment these strong standards, we have brackets, hangrods, hangrails, waterfalls etc., which we can supply in a finish to your specification (plated or paint).

Kember Store Metals with its complete in-house design department is also able to assist you in any design aspect for your store.

# SPECIFICATIONS

## KSM 5000 HEAVY DUTY 5/8" SLOT SYSTEM

is designed to meet all heavy merchandising needs. The heart of the system is the wall standard, manufactured from 14 gauge cold rolled steel with 5/8" x 1/8" slots on 1" centers. It is strong enough for areas selling hardware and heavy coats, but it's slim profile makes it suitable for merchandising requiring a lighter look. Because of the systems versatility, it is practical and economical to use throughout the store, both in sales and storage areas.

## KSM 9000 LIGHT DUTY 9/16" SLOT SYSTEM

is designed to meet all light merchandising needs. The standard is manufactured of 16 gauge cold rolled steel with 9/16" x slots on 1" centres. Ideal for areas where strength is not required such as shoes, greeting cards and light clothing.

location of slots and fixing holes common to all standards, furring strips & wall studs

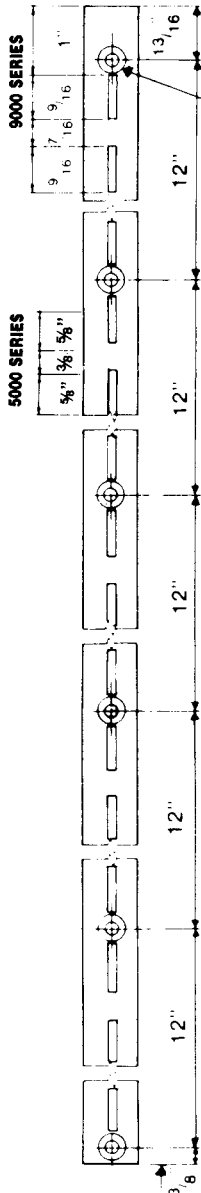

all surface mounted standards except # 9100 countersunk for # 10 woodscrews

### SINGLE SLOTTED STANDARD

Finish: Chrome plated

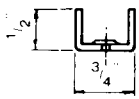

### DOUBLE SLOTTED STANDARD

Finish: Chrome plated

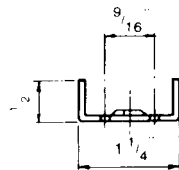

### SINGLE SLOTTED RECESSED STANDARD

Finish: To order

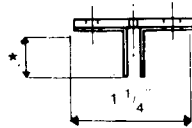

### WALL STUD

slotted one side only  
slotted both sides

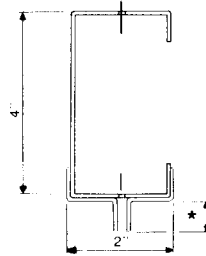

### SINGLE SLOTTED NARROW STANDARD

Finish: Chrome plated

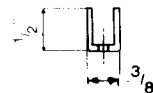

### FIRRING STRIP

\* PANEL THICKNESS + 1/16"  
When ordering always specify panel thickness being used

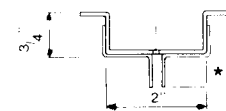

### BRACKETS, STRAIGHT nominal size 10" or less

Finish: Chrome plated.

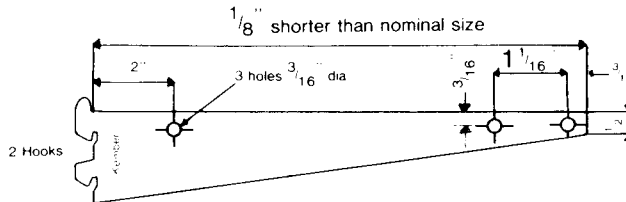

### BRACKETS, STRAIGHT nominal size over 10"

Finish: Chrome plated.

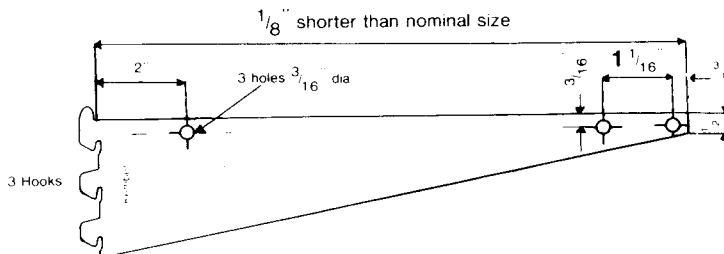

# SURFACE MOUNTED STANDARDS

## 5000 HEAVY DUTY SYSTEM

5/8" SLOT, 14 GAUGE STEEL STANDARD

### SINGLE SLOTTED STANDARD

<b>5001-36</b>	36" long
<b>5001-60</b>	60" long
<b>5001-72</b>	72" long
<b>5001-96</b>	96" long
<b>5001-120</b>	120" long
OR TO ORDER	



(NOT AVAILABLE)

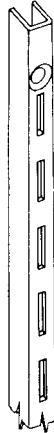

### DOUBLE SLOTTED STANDARD

<b>5003-36</b>	36" long
<b>5003-60</b>	60" long
<b>5003-72</b>	72" long
<b>5003-96</b>	96" long
<b>5003-120</b>	120" long
OR TO ORDER	

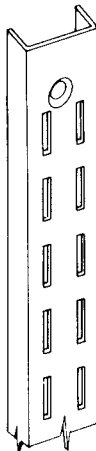

## 9000 LIGHT DUTY SYSTEM

9/16" SLOT, 16 GAUGE STEEL STANDARD

### SINGLE SLOTTED STANDARD

<b>9001-36</b>	36" long
<b>9001-60</b>	60" long
<b>9001-72</b>	72" long
<b>9001-96</b>	96" long
<b>9001-120</b>	120" long
OR TO ORDER	

### SINGLE SLOTTED NARROW STANDARD

<b>9002-96</b>	96" long
<b>9002-120</b>	120" long
OR TO ORDER	

### DOUBLE SLOTTED STANDARD

<b>9003-36</b>	36" long
<b>9003-60</b>	60" long
<b>9003-72</b>	72" long
<b>9003-96</b>	96" long
<b>9003-120</b>	120" long
OR TO ORDER	

**FINISH:** Chrome plated, other finishes to order.

# RECESSED WALL STANDARDS

## 5000 HEAVY DUTY SYSTEM

5/8" SLOT, 14 GAUGE STEEL STANDARD

## 9000 LIGHT DUTY SYSTEM

9/16" SLOT, 16 GAUGE STEEL STANDARD

### SINGLE SLOTTED RECESSED STANDARD

5004

120" long



### SINGLE SLOTTED RECESSED STANDARD

9004

120" long

### RECESSED STANDARD WITH ENCLOSED BACK

5005

OR TO ORDER

120" long



### RECESSED STANDARD WITH ENCLOSED BACK

9005

OR TO ORDER

120" long

### FIRING STRIP

c/w reversible "Z" mould. FINISH: primed grey.

5010

OR TO ORDER

120" long

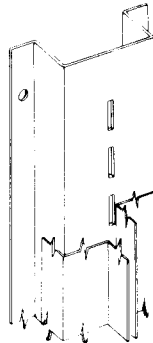

(NOT AVAILABLE)

### WALL STUD

c/w reversible "Z" mould slotted one side. FINISH: primed grey.

5011

120" long

5012 120" long (slotted both sides)

OR TO ORDER

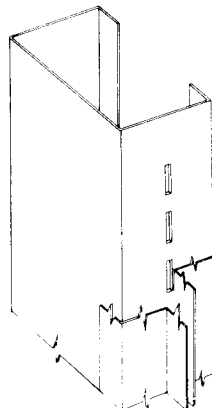

(NOT AVAILABLE)

When ordering please specify panel thickness being used.

# BRACKETS

## 5000 HEAVY DUTY SYSTEM

5/8" SLOT, 14 GAUGE STEEL STANDARD

## 9000 LIGHT DUTY SYSTEM

9/16" SLOT, 16 GAUGE STEEL STANDARD

### BRACKETS, STRAIGHT

(2 HOOKS)

**5020-8** 8"  
**5020-10** 10"

(3 HOOKS)

**5020-12** 12"  
**5020-14** 14"  
**5020-16** 16"  
**5020-18** 18"  
**5020-20** 20"

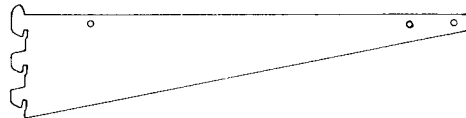
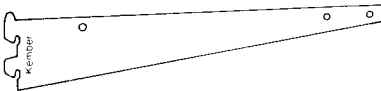

### BRACKETS, STRAIGHT

(2 HOOKS)

**9020-8** 8"  
**9020-10** 10"

(3 HOOKS)

**9020-12** 12"  
**9020-14** 14"  
**9020-16** 16"  
**9020-18** 18"  
**9020-20** 20"

### BRACKETS 15° SLOPE

**5021-12** 12"  
**5021-14** 14"  
**5021-16** 16"



### BRACKETS 15° SLOPE

**9021-12** 12"  
**9021-14** 14"  
**9021-16** 16"

### BRACKETS 30° SLOPE

**5022-12** 12"  
**5022-14** 14"  
**5022-16** 16"

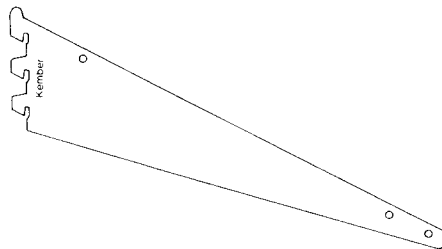

### BRACKETS 30° SLOPE

**9022-12** 12"  
**9022-14** 14"  
**9022-16** 16"

### STUB BRACKET

**5037** 1-1/2"



### STUB BRACKET

**9037** 1-1/2"

FINISH: Chrome plated.

# BRACKETS

## 5000 HEAVY DUTY SYSTEM

5/8" SLOT, 14 GAUGE STEEL STANDARD

## 9000 LIGHT DUTY SYSTEM

9/16" SLOT, 16 GAUGE STEEL STANDARD

### ADJUSTABLE BRACKET

5023-10	10" long
5023-12	12" long
5023-14	14" long
5023-16	16" long
5023-18	18" long

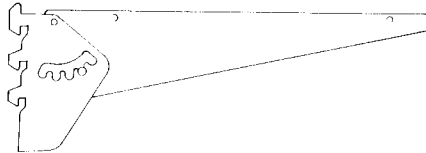

### ADJUSTABLE BRACKET

9023-10	10" long
9023-12	12" long
9023-14	14" long
9023-16	16" long
9023-18	18" long

### WOOD SHELF BRACKETS (Straight)

5027-1-	10"
5027-12	12"
5027-14	14"
5027-16	16"

ORDER LEFT & RIGHT

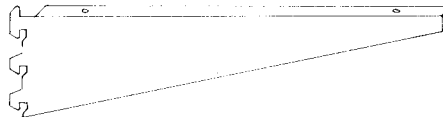

### WOOD SHELF BRACKETS (Straight)

9027-1-	10"
9027-12	12"
9027-14	14"
9027-16	16"

ORDER LEFT & RIGHT

### WOOD SHELF BRACKETS (Adjustable)

5024-1-	10"
5024-12	12"
5024-14	14"
5024-16	16"

ORDER LEFT & RIGHT

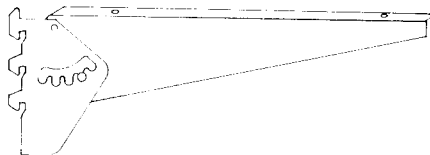

### WOOD SHELF BRACKETS (Adjustable)

9024-1-	10"
9024-12	12"
9024-14	14"
9024-16	16"

ORDER LEFT & RIGHT

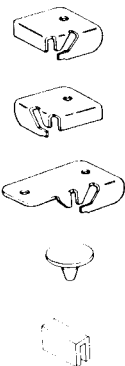

### SHELF CLIP

3001	Right Hand
3002	Left Hand
3003	Centre
3004	Rubber Rest
3005	Rubber Saddle

FINISH: Chrome plated, other finishes to order, please specify if being used with surface mounted, or recessed standards.

# ACCESSORY BRACKETS

## 5000 HEAVY DUTY SYSTEM

5/8" SLOT, 14 GAUGE STEEL STANDARD

## 9000 LIGHT DUTY SYSTEM

9/16" SLOT, 16 GAUGE STEEL STANDARD

### WATERFALL

5025-3	3 Notch
5025-6	6 Notch
5025-9	9 Notch
5025-12	12 Notch

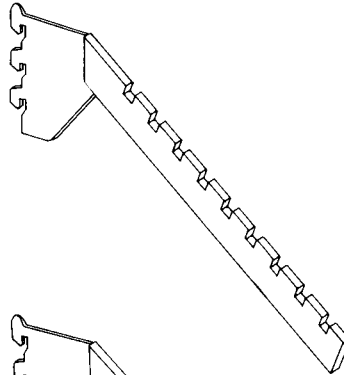

### WATERFALL

9025-3	3 Notch
9025-6	6 Notch
9025-9	9 Notch
9025-12	12 Notch

### (1/2" Dia. Steel Balls)

5015-3	3 Balls
5015-6	6 Balls
5015-9	9 Balls
5015-12	12 Balls

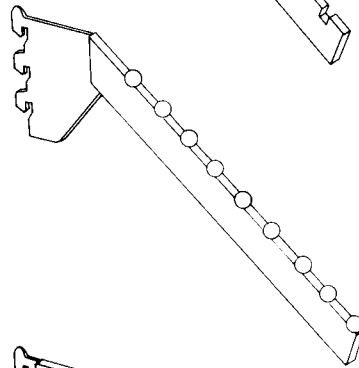

### (1/2" Dia. Steel Balls)

9015-3	3 Balls
9015-6	6 Balls
9015-9	9 Balls
9015-12	12 Balls

### STRAIGHT ARMS

5026-15	15"
5026-18	18"
OR TO ORDER	

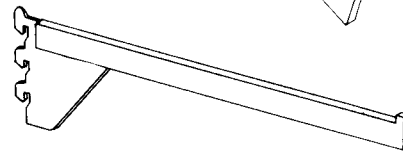

### STRAIGHT ARMS

9026-15	15"
9026-18	18"
OR TO ORDER	

### (1/2" Dia. Steel Ball)

5016-15	15"
5016-18	18"
OR TO ORDER	

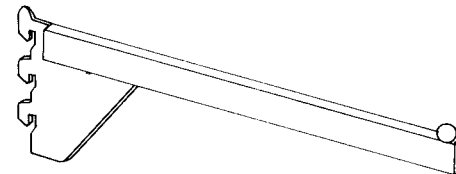

### (1/2" Dia. Steel Ball)

9016-15	15"
9016-18	18"
OR TO ORDER	

### HANDBAG DISPLAYER

5028	5 Hooks
------	---------

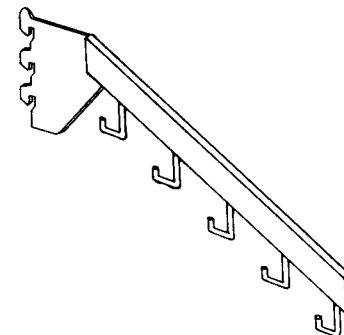

### HANDBAG DISPLAYER

9028	5 Hooks
------	---------

FINISH: Chrome plated, other finishes to order, please specify if being used with surface mounted, or recessed standards.

# HANGING SYSTEM

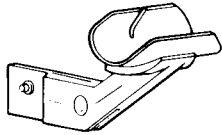

## HANGROD ADAPTER

Snap onto any Kember shelf bracket, then snap 1-1/4" dia. hangrod into clip.

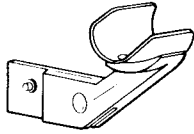

**3030**

Centre

**3031**

Left Hand

**3032**

Right Hand

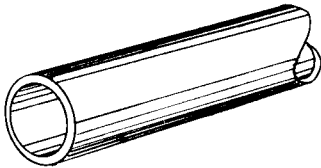
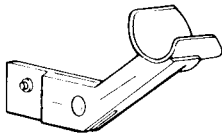

## HANGROD

Available in different dia. & gauges.

**3006-24**

24" long

**3006-48**

48" long

**3006-50**

60" long



## END CAPS (for 1-1/4" dia. rod)

**3008**

Push in type

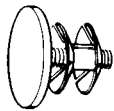

**3009**

Screw in type

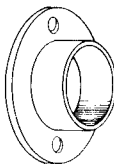

## FLANGES, SOCKETS

**3010**

For 1-1/4" dia. tubing

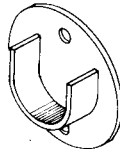

**3011**

For 1-1/4" dia. tubing

**FINISH: Chrome plated.**

# HANGING SYSTEM

**1/2" x 1-1/2" rail for use with 5000 & 9000 brackets**

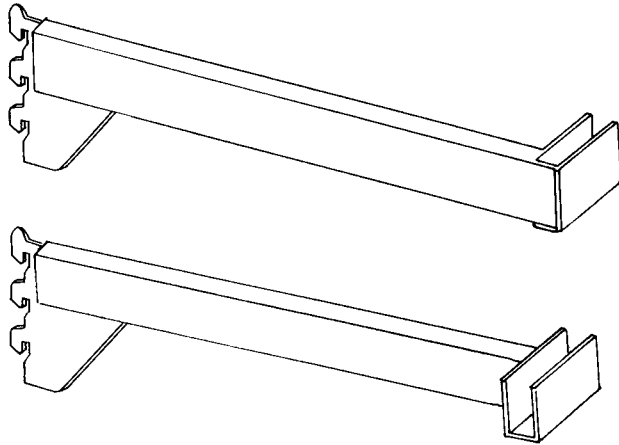

## HANGRAIL BRACKETS

5030-12	12" Right Hand	9030-12
5031-12	12" Left Hand	9031-12
5032-12	12" Centre	9032-12
5030-15	15" Right Hand	9030-15
5031-15	15" Left Hand	9031-15
5032-15	15" Centre	9032-15

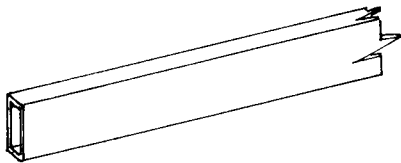

## HANGRAIL 1-1/4" x 1/2"

6006-24	24" long
6006-48	48" long

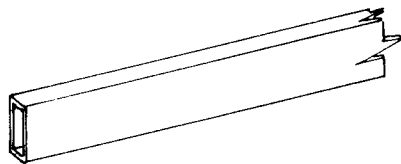

## HANGRAIL 1-1/2" x 1/2" (16 Gauge)

6007-24	24" long
6007-48	48" long

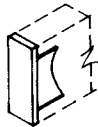

## END CAPS

6008	Flush
6009	Raised
6010	Plastic end caps, chrome look finish

**FINISH: Chrome plated, other finishes to order, please specify if being used with surface mounted, or recessed standards.**

# HANGRAIL ACCESSORY BRACKETS

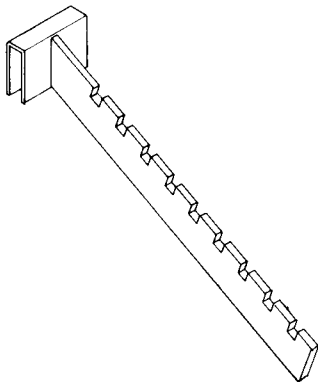

**WATERFALL**

- |                |          |
|----------------|----------|
| <b>6025-3</b>  | 3 Notch  |
| <b>6025-6</b>  | 6 Notch  |
| <b>6025-9</b>  | 9 Notch  |
| <b>6025-12</b> | 12 Notch |

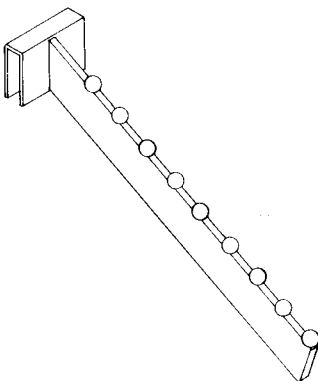

**(1/2" Dia. Steel Balls)**

- |                |          |
|----------------|----------|
| <b>6015-3</b>  | 3 Balls  |
| <b>6015-6</b>  | 6 Balls  |
| <b>6015-9</b>  | 9 Balls  |
| <b>6015-12</b> | 12 Balls |

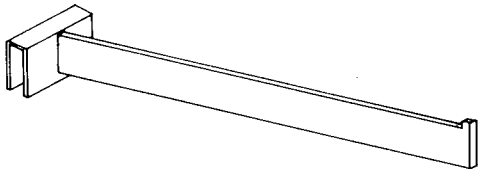

**STRAIGHT ARMS**

- |                |     |
|----------------|-----|
| <b>6026-15</b> | 15" |
| <b>6026-18</b> | 18" |
| OR TO ORDER    |     |

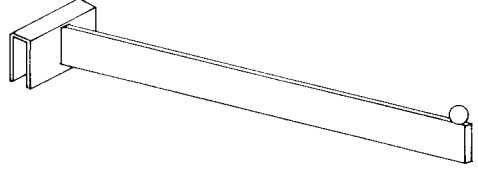

**(1/2" Dia. Metal Balls)**

- |                |     |
|----------------|-----|
| <b>6016-15</b> | 15" |
| <b>6016-18</b> | 18" |
| OR TO ORDER    |     |

**FINISH:** Chrome plated, other finishes to order.

# HANGRAIL ACCESSORY BRACKETS

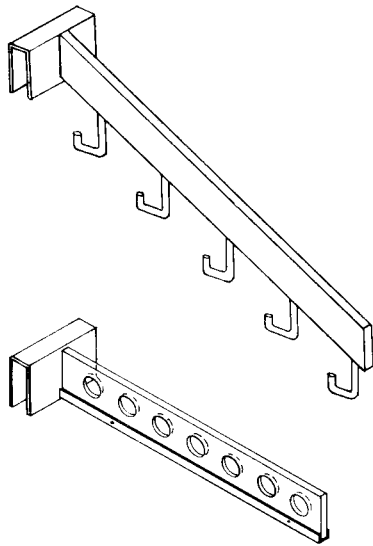

## HANDBAG DISPLAY

6028

5 Hook

## SCARF HOLDER

Plexiglass

6038

Holds 7 Scarves

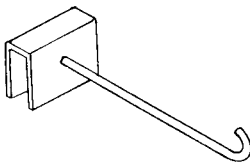

## SINGLE HOOKS

With 1/2" return safety feature

6033-3

3" long

6033-6

6" long

6033-9

9" long

6033-12

12" long

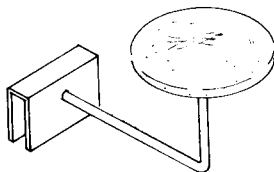

## HAT ARM

6039

3" dia. foam cushion

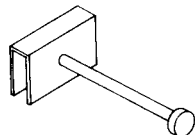

## HANGER

6051

4" long 1/2" dia. stem, with  
1" dia. x 1/2" thick front stop

FINISH: Chrome plated, other finishes to order.

# SLATWALL ACCESSORY BRACKETS

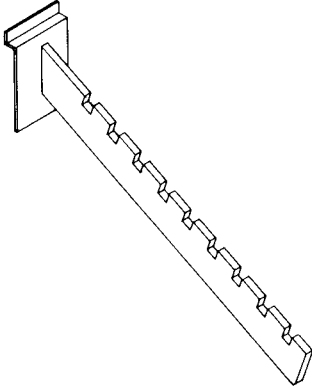

## WATERFALL

7025-3	3 Notch
7025-6	6 Notch
7025-9	9 Notch
7025-12	12 Notch

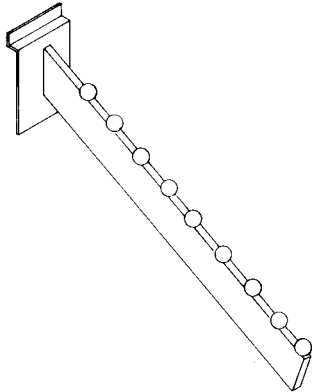

## (1/2" Dia. Steel Balls)

7015-3	3 Balls
7015-6	6 Balls
7015-9	9 Balls
7015-12	12 Balls

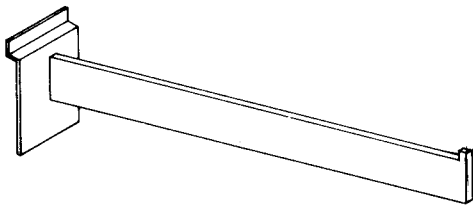

## STRAIGHT ARMS

7026-15	15"
7026-18	18"
OR TO ORDER	

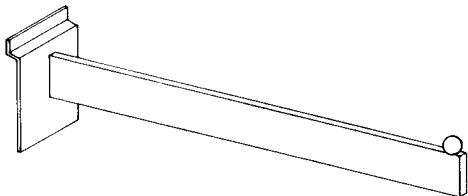

## (1/2" Dia. Metal Balls)

7016-15	15"
7016-18	18"
OR TO ORDER	

**FINISH:** Chrome plated or baked enamel to order. Specify size of slatwall to be used.

# SLATWALL ACCESSORY BRACKETS

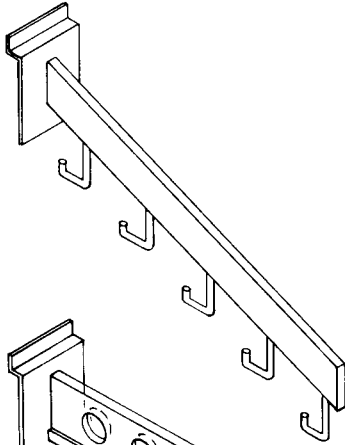

## HANDBAG DISPLAY

7028

5 Hook

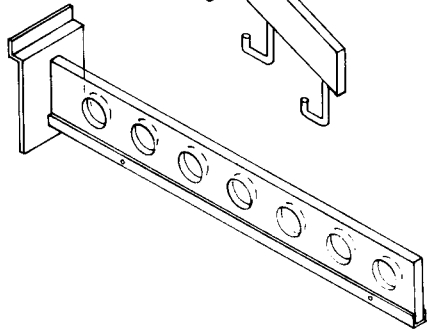

## SCARF HOLDER

Plexiglass

7038

Holds 7 Scarves

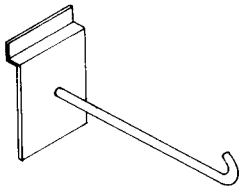

## SINGLE HOOKS

With 1/2" return safety feature

7033-3

3" long

7033-6

6" long

7033-9

9" long

7033-12

12" long

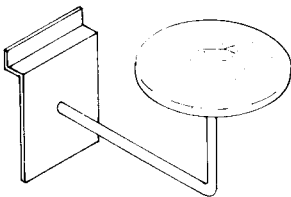

## HAT ARM

7039

3" dia. foam cushion

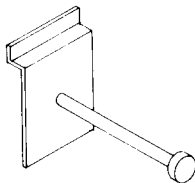

## HANGER

7051

4" long 1/2" dia. stem, with  
1" dia. x 1/2" thick front stop

**FINISH:** Chrome plated or baked enamel to order. Specify size of slatwall to be used.

# FITTING ROOM HARDWARE

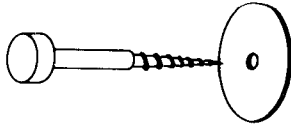

## FITTING ROOM HOOKS

**3040** Single — ½" dia. x 4" long  
1" dia. knob

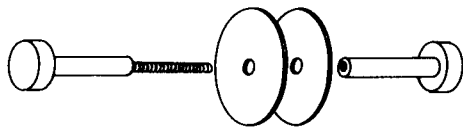

**3041** Double — ½" dia. x 4" long  
each side, 1" dia. knob

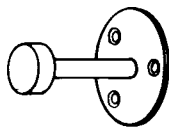

## COAT HOOK

**3042** ½" dia. x 3½" long  
1" dia. knob

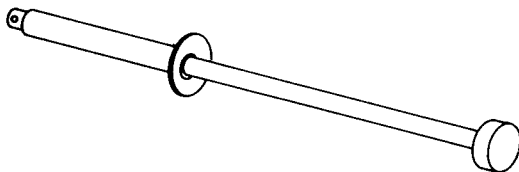

## PULLOUT HANGER

**3044** Fits in hole ⅝" long x 3⅜"

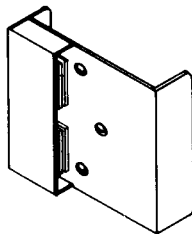

## MAGNETIC DOOR PULL

**3045** 3⅝" long x 3⅜" high

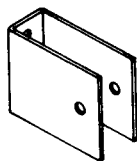

## PANEL CLAMPS

**3046** 2½" long x 1" wide x 2" high

**FINISH:** Chrome plated.

# KEMBER STORE METALS LIMITED

## CONDITIONS OF SALE

- TERMS:** Established accounts strictly thirty (30) days. All other orders C.O.D.  
Minimum order \$50.00.
- PRICES:** Are subject to change or withdrawal without notice. Prices on date of shipment will apply, unless previously quoted.  
Custom matched colours and/or finishes will be subject to surcharge on small orders.
- TAXES:** All taxes are extra where applicable.
- SHIPPING:** All purchases are F.O.B. our plant, unless otherwise specified.  
Estimated shipping dates given by the company are an approximation only, while the company makes every effort to meet estimated shipping dates, the company declines any and all liability for delays due to strikes, fire damages, delays in shipment by the company's own suppliers, or any other circumstances beyond the control of the company.
- SHIPPING INSTRUCTIONS:** Should be specified on each individual order. The company does not assume responsibility for shipping costs of any kind whatsoever.
- SHORTAGE CLAIMS:** Please check all goods received promptly on arrival. No shortage claim will be accepted by the company unless made within 24 hours of receipt of the goods.
- RETURN & EXCHANGES:** No merchandise may be returned for credit or exchange without the company's written permission. A minimum restocking charge of \$25.00 or 15% of the net value of the returned merchandise, whichever is greater, shall apply. Returned freight must be prepaid.
- MADE TO ORDER GOODS:** Goods made to a customer's own specifications are not returnable nor subject to cancellation under any circumstances. All orders, contracts, or other agreements are subject to acceptance by head office and to company terms of sale. Any errors are subject to correction.